

# jaga

CLIMATE DESIGNERS



## DBH UPGRADE SET





# DBH UPGRADE SET

<b>INHOUDSOPGAVE</b>	<b>3</b>	<b>TECHNISCHE TABEL</b>	<b>12</b>
<b>INLEIDING</b>	<b>5</b>	DBH set 10 + Low-H20 type 10	12
<b>EEN RENOVATIEVOORBEELD VOOR / NA</b>	<b>6</b>	DBH set 10 + Low-H20 type 11	13
<b>VOOR WELKE RADIATOREN?</b>	<b>7</b>	DBH set 15 + Low-H20 type 15	14
<b>VERVANGING VAN ANDERE RADIATOREN</b>	<b>7</b>	DBH set 15 + Low-H20 type 16	15
<b>WELKE DBH UPGRADE SET</b>	<b>8</b>	DBH set 15 + Low-H20 type 20	16
Standaard levering	8	DBH set 15 + Low-H20 type 21	17
Hoe kies ik de juiste set?	8	<b>EENVOUDIGE INSTALLATIE</b>	<b>18</b>
<b>GELUIDSDRUKNIVEAU</b>	<b>9</b>	<b>CORRECTIEFACTOREN</b>	<b>19</b>
Geluid en vermogen volgens de nieuwste Europese normen	9	<b>RICHTLIJN VOOR HET BEPERKEN VAN STROMINGSGELUIDEN</b>	<b>20</b>
Hoe hard klinkt een decibel?	9	<b>DRUKVERLIES</b>	<b>21</b>
Hoe DBH selecteren?	9	Low-H20 Type 10	21
<b>STURINGEN</b>	<b>10</b>	Low-H20 Type 11	22
<b>WELKE JAGA STURING KIEZEN?</b>	<b>11</b>	Low-H20 Type 15	23
		Low-H20 Type 16	24
		Low-H20 Type 20	25
		Low-H20 Type 21	26



# DBH UPGRADE SET

## DE EENVOUDIGSTE WEG NAAR EEN MILIEUVRIENDELIJKE KLIMAATINSTALLATIE

- omschakeling naar lage temperatuur verwarming met warmtepomp of lage temperatuur ketel
- geschikt voor milieuvriendelijke light cooling (Niet-condenserend)
- met Breeze functie voor een ventilator-effect (\* enkel bij ACO sturing)
- eenvoudige installatie op alle Jaga Low-H<sub>2</sub>O radiatoren

### VAN DE ONTWERPERS VAN DE EERSTE DYNAMISCHE LAGE TEMPERATUUR RADIATOR

De DBH Upgrade set is een speciaal voor Jaga Low-H<sub>2</sub>O radiatoren ontwikkelde booster om het vermogen te verhogen en om te koelen met een zeer laag energieverbruik. Deze set maakt het mogelijk om de watertemperatuur van uw C.V.-installatie sterk te verlagen zonder de radiatoren te vergroten of leidingen te moeten wijzigen. Het upgraden van uw bestaande Jaga radiatoren met de DBH set is de eenvoudigste weg naar elke lage temperatuur installatie of emissievrije warmtepomp-installatie voor verwarmen én light cooling.

OOK GESCHIKT  
VOOR JAGA  
LIGHT COOLING



- energiezuinig niet-condenserend koelen in combinatie met elke warmtepomp die koelwater kan leveren
- verbetert het seizoensrendement van elke warmtepomp
- laat condenserende ketels op hun laagste temperatuur en hoogste rendement werken

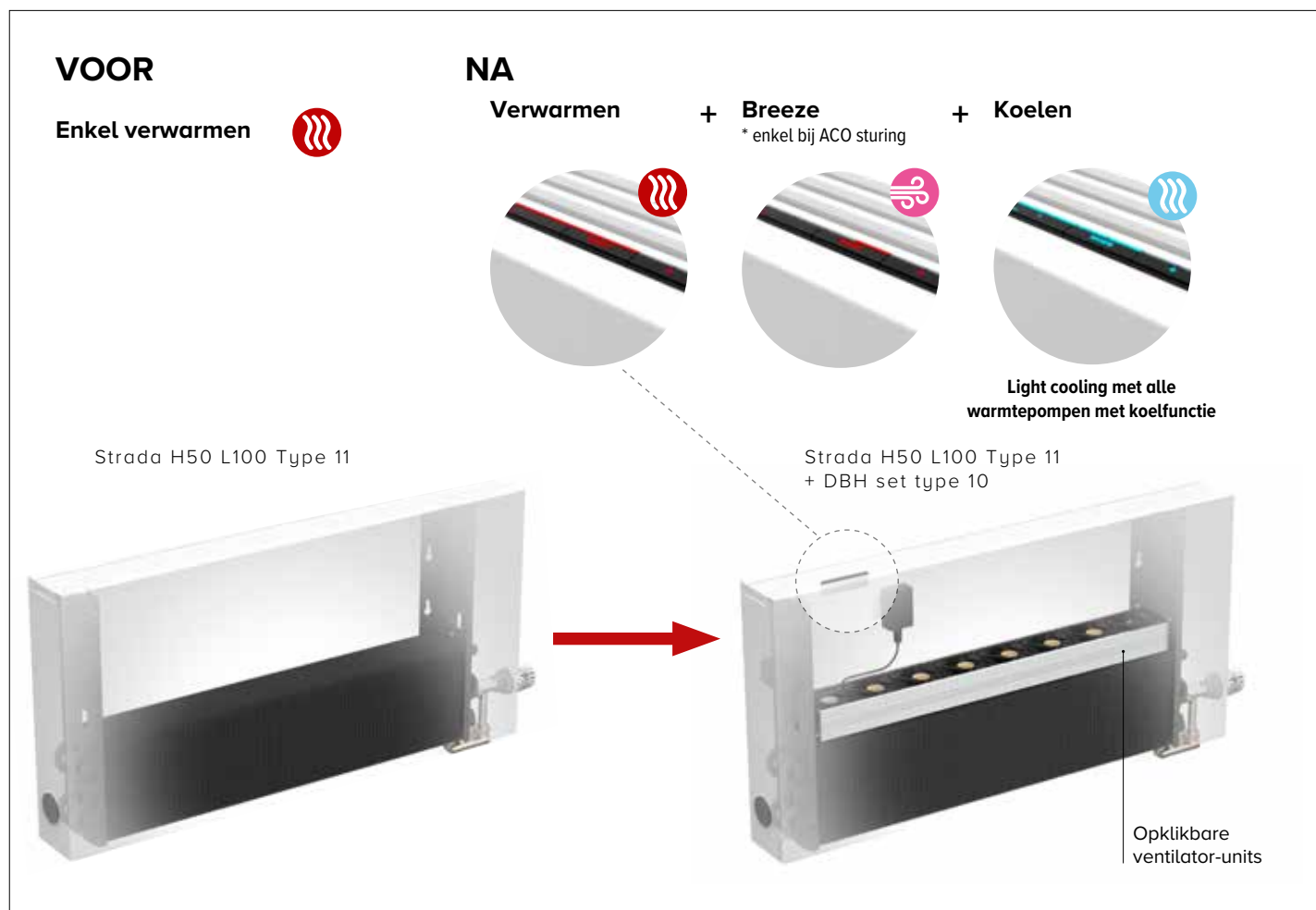

## AFGIFTE ZONDER DBH

Regime	
75/65	1386 Watt
55/45	665 Watt
45/35	388 Watt

## AFGIFTE MET DBH

Regime	Stand 2	Stand 3
55/45	1303 Watt	1600 Watt
45/35	823 Watt	1011 Watt
35/30	495 Watt	608 Watt

## KOELEN MET DBH

473 WATT  
bij regime  
16/18/27°

## DBH UPGRADE SET

## VOOR WELKE RADIATOREN?

Bijna alle Jaga Low-H<sub>2</sub>O radiatoren kunnen uitgerust worden met de DBH Upgrade set:  
Voor meer info over DBH Upgrade Set, zie [www.jaga.com](http://www.jaga.com)

### TEMPO

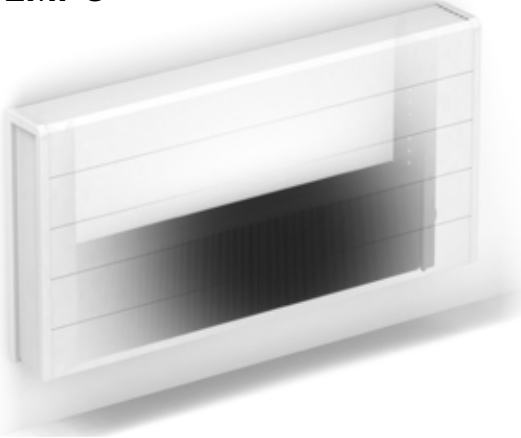

### WANDINBOUW

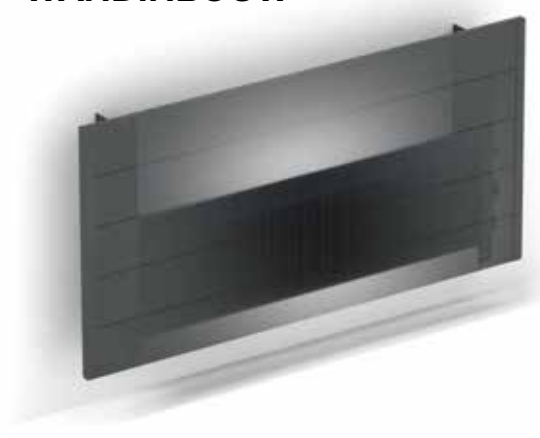

### STRADA

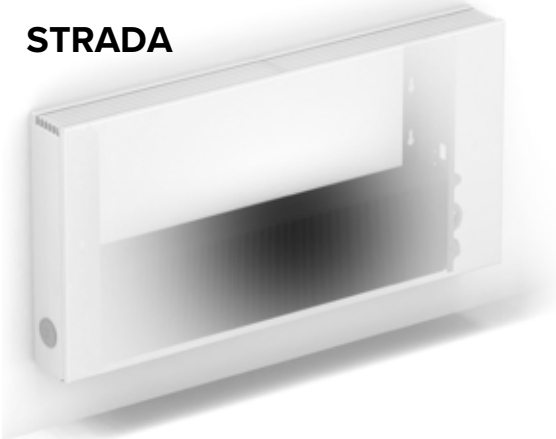

### LINEA PLUS



## VERVANGING VAN ANDERE RADIATOREN

Gewone paneelradiatoren zijn niet geschikt voor een upgrade met DBH. Wel kan u deze vervangen door een Jaga radiator met dezelfde afmetingen als de oude radiatoren.  
Zo kan u toch voldoende vermogen installeren om over te gaan naar lagere watertemperaturen zonder plaatsverlies vanwege extra radiatoren of grotere radiatoren.

**75/65**



**55/45**



## DBH UPGRADE SET

## WELKE DBH UPGRADE SET?

### STANDAARD LEVERING

- ventilator-unit(s)
- stuurprint met microcontroller en bediening
- netadapter 230V / 24VDC

### BESTELCODE

DBHS 050 10 D01 EU

Sturing:

D01 (Jaga TPT)

D03 (Jaga BMS 0-10V regeling)

D09 (Jaga ACO)

DBH Upgrade set:

10 (DBH unit 10)

15 (DBH unit 10)

Lengte radiator

### HOE KIES IK DE JUISTE SET?

- Meet de dikte en de lengte van uw Low-H<sub>2</sub>O radiator.
- Dikte 11,5 cm = DBH unit 10
- Dikte 16,5 cm = DBH unit 15
- Dikte 21,5 cm = DBH unit 15
- De lengtemaat van de bekleding bepaalt tevens de lengtemaat van de te bestellen DBH set.

### DBH UNIT 10

geschikt voor type 10 en 11:

- |   |                             |
|---|-----------------------------|
| - Strada                                  | - Tempo                     |
| - type 10 (min. hoogte 020)               | - type 10 (min. hoogte 020) |
| - type 11 (min. hoogte 035)               | - type 11 (min. hoogte 030) |
| - Linea Plus                              | - Wandinbouw                |
| - type 10 en type 11<br>(min. hoogte 035) | - type 10 (min. hoogte 020) |
|   | - type 11 (min. hoogte 030) |

### DBH UNIT 15

geschikt voor type 15, 16, 20 en 21:

- |  |                                 |
|--|---------------------------------|
| - Strada                                     | - Tempo                         |
| - type 15, 20 (min. hoogte 020)              | - type 15, 20 (min. hoogte 020) |
| - type 16, 21 (min. hoogte 035)              | - type 16, 21 (min. hoogte 030) |
| - Linea Plus                                 | - Wandinbouw                    |
| - type 15, 16, 20 en 21<br>(min. hoogte 035) | - type 15, 20 (min. hoogte 020) |
|  | - type 16, 21 (min. hoogte 030) |



type 10

type 11



type 15

type 16

type 20

type 21



## GELUID EN VERMOGEN VOLGENS DE NIEUWSTE EUROPESE NORMEN

Het vermogen van Jaga radiatoren met DBH set, zowel verwarming als koeling, werd gemeten volgens de laatste Europese normering, specifiek voor radiatoren met geïntegreerde ventilatoren. Jaga voldoet hiermee als één van de eersten aan de nieuwe referentienorm **EN16430**. Het geluidsvermogen (Lw) van de DBH is gemeten volgens ISO 3741:2010. Zoals gebruikelijk wordt voor de geluidsdrukkniveau (Lp) een ruimtedemping aangenomen van 8 dB(A) bij een lokaalinhoud van 100 m<sup>3</sup> en een nagalmtijd van 0.5 sec.

## HOE HARD KLINKT EEN DECIBEL?

DB(A)	BELEVING	VOORBEELDEN
10	bijna niet te horen	ademhaling, vallend blaadje
20	net hoorbaar	radiostudio, ruisen van boomblaadjes
30	erg stil	bibliotheek ( 30 tot 40 ), fluisteren
40	stil	huiskamer, stil klaslokaal, zacht geroezemoes, koelkast
50	beperkt geluid	airconditioning, normale conversatie, vaatwasser

## HOE DBH SELECTEREN?







DBH wordt geselecteerd in **comfortstand, stand 2** vetgedrukt in afgifтетabellen. Dit garandeert een stille werking op maximaal 30 dB(A). Stand 1 is een superstille slaapkamerstand met maximaal 26 dB(A). Stand 3 zorgt voor een maximale boost en de zeer hoge afgifte dient vooral om een lokaal zo snel mogelijk op te warmen en te koelen. In deze stand ligt het geluid tussen 42 en 46 dB(A).

## STURINGEN

BEDIENINGSPANEEL



JDPC (Jaga Dynamic Product Controller)

TYPE	FUNCTIE	BEDIENINGSPANEEL	EXTERNE 0-10 V AANSTURING	WATERTEMP. SENSOR	LUCHTTEMP. SENSOR
Jaga ACO (D09)	  	✓	-	✓	✓
Jaga BMS 0-10V regeling (D03)	 	-	✓	✓	-
Jaga TPT (D01)	 	✓	-	✓	✓

**JAGA ACO (D09)**

- De ventilatorsnelheid wordt manueel in 3 standen gekozen via het bedieningspaneel.
- Wanneer de watertemperatuur lager is als 24°C en de lucht warmer is dan het water in de warmtewisselaar starten de ventilatoren. Het toestel koelt dan de ruimte.
- Wanneer de watertemperatuur hoger is als 28°C en de lucht kouder is dan het water starten de ventilatoren. Het toestel verwarmt dan de ruimte.
- Het toestel **schakelt automatisch** van verwarmen naar koelen en naar stand-by mode.

**JAGA BMS 0-10V REGELING (D03)**

- De ventilatorsnelheid wordt enkel **aangestuurd door een 0-10V (DC) signaal** dat van een extern regelsysteem aangelegd wordt aan de elektronica van het toestel. Het 0-10V signaal kan aangelegd worden van een Jaga thermostaat of een ander domotica- of gebouwbeheersysteem.
- Wanneer de stuurspanning 1V of hoger is en de watertemperatuur hoger is dan 28°C of lager is dan 24°C starten de ventilatoren. Het toerental loopt evenredig op met de aangelegde stuurspanning. Bij 10V stuurspanning draaien de ventilatoren op maximaal toerental.
- Wanneer een Hybrid toestel met Jaga BMS sturing uitgerust wordt met een **thermo-elektrische ventielmotor** die op de interne elektronica aangesloten is, dan opent het ventiel wanneer de stuurspanning hoger is dan 1V.

**JAGA TPT (D01)**

- De ventilatorsnelheid wordt automatisch gestuurd in functie van de ingestelde comforttemperatuur via de tiptoetsbediening. Hierdoor wordt het toestel zeer stil wanneer de comforttemperatuur bereikt is.
- Wanneer een Hybrid toestel met Jaga TPT sturing uitgerust wordt met een thermo-elektrische ventielmotor die op de interne elektronica aangesloten is, dan neemt het toestel de functie van kamerthermostaat over. Het toestel zal dan zelf op basis van kamertemperatuurmeting het waterdebiet door het toestel in- of uitschakelen. Wanneer de watertemperatuur in de warmtewisselaar lager is dan 24°C starten de ventilatoren. Het toestel koelt dan de ruimte.
- Wanneer men de **kamertemperatuur wenst in te stellen** via een ander systeem dat het waterdebiet door het toestel in- of uitschakelt, dan dient men geen thermo-elektrische ventielmotor op de interne controller aan te sluiten. De TPT sturing zal dan enkel het ventilatoroerental sturen op basis van de ingestelde comforttemperatuur. Intuïtief gebruikt men de tiptoetsbediening dan om meer of minder ventilatorondersteuning te krijgen bij het bereiken van de comforttemperatuur.
- Wanneer de watertemperatuur in de warmtewisselaar lager is dan 24°C starten de ventilatoren. Het toestel koelt dan de ruimte.
- Wanneer de watertemperatuur hoger is als 28°C starten de ventilatoren. Het toestel verwarmt dan de ruimte.

Wens je kamertemperatuurregeling op het toestel?

**Ja, kamertemperatuurregeling in het toestel**  
Ventilatoren starten automatisch wanneer de interne regeling warm/koud water door de radiator stuurt

**Nee, kamertemperatuurregeling buiten het toestel**  
Ventilatoren starten automatisch wanneer de externe regeling warm/koud water door de radiator stuurt

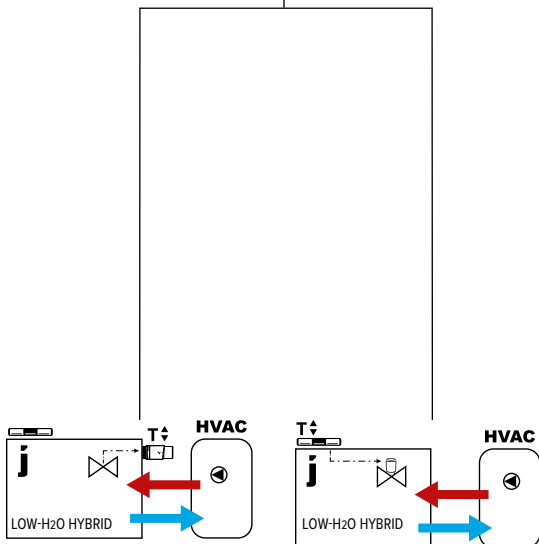
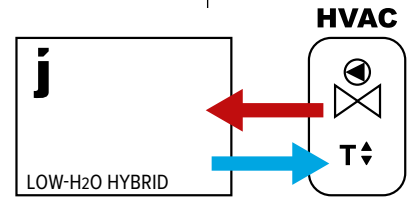
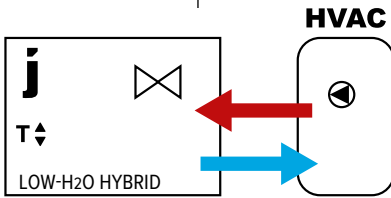

Verwarming: temperatuurregeling via thermostatisch radiatorventiel (TRV)  
Koeling: thermostaatkop / adapter staat op koelstand, geen temperatuurregeling

Temperatuurregeling via bedieningspaneel op toestel (thermo-elektrisch ventiel in de radiator aangesloten op elektronica van het toestel)

Ventilatorsnelheid wordt bepaald door 3-standenbediening

Ventilatorsnelheid past zich aan, aan de kamertemperatuur en de ingestelde gewenste kamertemperatuur (via tiptoetsbediening)

JAGA ACO

JAGA TPT

Codering: D09

D01

Zonder 0-10V signaal:

- kamerthermostaat (Geen-Jaga)
- zoneregeling met kamertemp. regeling
- ketel- of warmtepompsturing met kamertemp. regeling
- domotica met kamertemp. regeling
- andere externe kamertemp. regelingen

0-10V signaal voor ventilatorsturing beschikbaar van

- Jaga kamerthermostaat met 0-10V signaal naar toestel
- domotica beschikbaar met 0-10V signaal naar toestel

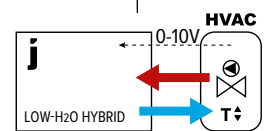
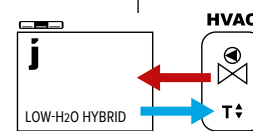
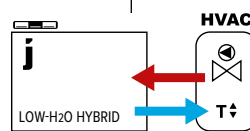

Kies 1 van de 3 ventilatorsnelheden (snelheid past zich niet aan, aan de kamertemperatuur)

Ventilatorsnelheid past zich aan, aan de kamertemperatuur. Stel het temperatuurbereik in via het bedieningspaneel.

Ventilatorsnelheid wordt gestuurd door 0-10V aansluiting op de elektronica in de radiator.

JAGA ACO

JAGA TPT

JAGA BMS

D09

D01

D03

# DBH SET 10 + LOW-H2O TYPE 10

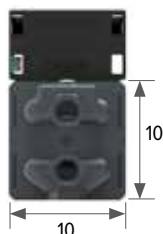

LENGTE RADIATOR	DBH SET	STAND	KOELLEN Kamertemperatuur 27°C		VERWARMEN Kamertemperatuur 20°C				GELUIDSDRUK*	OPGENOMEN ELEKTRISCH VERMOGEN	GEWICHT	WATERINHOUD	BESTELCODE
			16/18	20/22	35/30	45/40	50/45	55/45					
			Watt	Watt	Watt	Watt	Watt	Watt					
DBHS 050	10	1	90	54	144	274	340	371	26	3.6			DBHS 050 10 DDD EU
		2	96	58	154	293	365	398					
		3	113	68	180	342	426	465					
060		1	117	70	186	355	442	482	26	4.8			DBHS 060 10 DDD EU
		2	125	75	199	380	473	516					
		3	148	89	236	450	559	610					
070		1	143	86	228	434	540	589	26	5.5			DBHS 070 10 DDD EU
		2	153	92	244	466	579	632					
		3	183	110	292	557	693	756					
080		1	168	101	269	512	637	695	26	6.3			DBHS 080 10 DDD EU
		2	181	109	289	550	684	746					
		3	218	132	348	664	826	901					
090		1	193	117	309	589	732	799	26	6.7			DBHS 090 10 DDD EU
		2	208	125	332	633	788	859					
		3	253	153	405	771	959	1046					
100		1	218	132	348	664	826	901	26	7.8			DBHS 100 10 DDD EU
		2	235	142	375	715	890	971					
		3	289	174	461	878	1092	1191					
110		1	245	148	391	745	927	1011	26	8.4			DBHS 110 10 DDD EU
		2	264	159	421	803	998	1089					
		3	324	195	517	985	1226	1337					
120		1	267	161	426	812	1010	1102	26	8.9			DBHS 120 10 DDD EU
		2	288	174	460	877	1091	1190					
		3	359	216	573	1092	1359	1482					
140		1	314	189	502	957	1190	1298	26	10.1			DBHS 140 10 DDD EU
		2	341	205	544	1036	1289	1406					
		3	429	259	685	1307	1625	1773					
160		1	361	218	576	1098	1366	1490	26	11			DBHS 160 10 DDD EU
		2	392	236	626	1192	1483	1618					
		3	500	301	798	1521	1892	2063					
180		1	412	248	657	1253	1559	1700	26	12.2			DBHS 180 10 DDD EU
		2	447	269	714	1360	1692	1845					
		3	570	344	910	1735	2158	2354					
200		1	452	272	721	1375	1710	1865	26	13.4			DBHS 200 10 DDD EU
		2	493	297	786	1499	1864	2033					
		3	641	386	1023	1949	2424	2644					
220		1	494	297	788	1502	1868	2038	26	13.4			DBHS 220 10 DDD EU
		2	539	325	861	1641	2041	2226					
		3	711	428	1135	2163	2691	2935					
240		1	535	323	854	1628	2025	2209	26	14.8			DBHS 240 10 DDD EU
		2	586	353	936	1784	2219	2420					
		3	781	471	1247	2377	2957	3225					
260		1	579	349	925	1762	2192	2391	26	16.2			DBHS 260 10 DDD EU
		2	639	385	1020	1944	2418	2637					
		3	852	513	1360	2592	3224	3516					
280		1	588	354	959	1827	2272	2479	26	16.2			DBHS 280 10 DDD EU
		2	649	391	1058	2017	2509	2737					
		3	864	521	1410	2687	3342	3645					

Afgiftes gemeten volgens EN 16430.

sturing:  
Jaga ACO (D09)  
Jaga BMS 0-10V regeling (D03)  
Jaga TPT (D01)

# DBH SET 10 + LOW-H2O TYPE 11



LENGTE RADIATOR			KOELLEN Kamertemperatuur 27°C				VERWARMEN Kamertemperatuur 20°C				GELUIDSDRUK*				BESTELCODE		
L	B	DBH SET	16/18	20/22	35/30	45/40	50/45	55/45	OPGENOMEN ELEKTRISCH VERMOGEN	GEWICHT	WATERINHOUD		dB(A)	Watt		kg	L
cm	cm	STAND	Watt	Watt	Watt	Watt	Watt	Watt	kg	L							
DBHS	050	10	1	148	90	190	366	457	499	26	3.6				DBHS 050 10 DDD EU		
			2	158	97	203	391	489	534								
			3	185	113	237	458	572	624								
060	1	1	191	117	246	474	592	647	26	4.8			DBHS 060 10 DDD EU				
		2	205	125	263	508	634	693									
		3	242	148	311	601	750	819									
070	1	1	234	143	301	580	724	791	26	5.5			DBHS 070 10 DDD EU				
		2	251	154	322	622	777	849									
		3	300	184	386	744	929	1015									
080	1	1	276	169	355	684	854	933	26	6.3			DBHS 080 10 DDD EU				
		2	296	181	381	735	917	1002									
		3	358	219	460	887	1107	1210									
090	1	1	317	194	408	786	982	1072	26	6.7			DBHS 090 10 DDD EU				
		2	341	209	438	846	1056	1154									
		3	415	254	534	1030	1286	1405									
100	1	1	358	219	460	887	1107	1210	26	7.8			DBHS 100 10 DDD EU				
		2	385	236	495	955	1193	1303									
		3	473	289	608	1173	1464	1600									
110	1	1	401	246	516	995	1242	1357	26	8.4			DBHS 110 10 DDD EU				
		2	432	265	556	1072	1339	1462									
		3	531	325	682	1316	1643	1795									
120	1	1	437	267	562	1084	1354	1479	26	8.9			DBHS 120 10 DDD EU				
		2	473	289	607	1171	1463	1598									
		3	589	360	756	1459	1822	1990									
140	1	1	515	315	662	1277	1595	1743	26	10.1			DBHS 140 10 DDD EU				
		2	558	342	717	1383	1728	1887									
		3	704	431	904	1745	2179	2380									
160	1	1	592	362	760	1467	1832	2001	26	11			DBHS 160 10 DDD EU				
		2	642	393	825	1592	1988	2172									
		3	819	501	1053	2031	2536	2771									
180	1	1	675	413	867	1673	2090	2283	26	12.2			DBHS 180 10 DDD EU				
		2	733	449	942	1816	2268	2478									
		3	935	572	1201	2317	2893	3161									
200	1	1	741	453	952	1836	2293	2505	26	13.4			DBHS 200 10 DDD EU				
		2	807	494	1037	2001	2499	2730									
		3	1050	643	1349	2603	3250	3551									
220	1	1	809	495	1040	2005	2505	2736	26	13.4			DBHS 220 10 DDD EU				
		2	884	541	1136	2191	2737	2990									
		3	1166	713	1498	2889	3608	3941									
240	1	1	877	537	1127	2174	2715	2967	26	14.8			DBHS 240 10 DDD EU				
		2	961	588	1235	2382	2975	3250									
		3	1281	784	1646	3175	3965	4331									
260	1	1	950	581	1220	2353	2939	3211	26	16.2			DBHS 260 10 DDD EU				
		2	1047	641	1346	2596	3241	3541									
		3	1396	855	1794	3461	4322	4722									
280	1	1	956	585	1286	2481	3098	3385	26	16.2			DBHS 280 10 DDD EU				
		2	1056	646	1420	2739	3421	3737									
		3	1406	860	1892	3649	4557	4978									

Afgiftes gemeten volgens EN 16430.

sturing:  
Jaga ACO (D09)  
Jaga BMS 0-10V regeling (D03)  
Jaga TPT (D01)

# DBH SET 15 + LOW-H2O TYPE 15

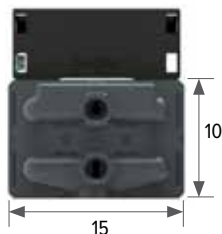

LENGTE RADIATOR L cm	DBH SET B cm	STAND	KOELEN Kamertemperatuur 27°C		VERWARMEN Kamertemperatuur 20°C				GELUIDSDRUK* dB(A)	OPGENOMEN ELEKTRISCH VERMOGEN Watt	GEWICHT kg	WATERINHOUD L	BESTELCODE
			16/18 Watt	20/22 Watt	35/30 Watt	45/40 Watt	50/45 Watt	55/45 Watt					
DBHS 060	15	1	131	78	212	404	502	548	41.1	7.2			DBHS 060 15 DDD EU
		2	140	83	227	433	539	588					
		3	186	110	301	574	713	778					
070		1	135	80	237	452	562	613	41.1	7.2			DBHS 070 15 DDD EU
		2	145	86	254	485	603	658					
		3	192	114	337	642	798	871					
080		1	190	113	309	589	732	798	42.4	9.0			DBHS 080 15 DDD EU
		2	204	121	331	631	785	856					
		3	274	163	444	847	1053	1149					
090		1	218	129	354	674	838	914	43.3	10.7			DBHS 090 15 DDD EU
		2	234	139	379	722	898	980					
		3	318	189	516	983	1223	1334					
100		1	246	146	398	759	944	1029	44.1	10.7			DBHS 100 15 DDD EU
		2	263	156	426	812	1011	1102					
		3	362	215	588	1120	1393	1519					
110		1	250	148	422	805	1001	1092	44.1	12.5			DBHS 110 15 DDD EU
		2	267	159	452	862	1072	1169					
		3	369	219	623	1188	1478	1612					
120		1	303	180	491	935	1163	1269	44.8	14.3			DBHS 120 15 DDD EU
		2	324	192	525	1001	1246	1358					
		3	451	267	731	1393	1733	1890					
140		1	359	213	582	1109	1379	1504	45.4	16.1			DBHS 140 15 DDD EU
		2	384	228	623	1188	1477	1611					
		3	539	320	874	1666	2073	2261					
160		1	412	245	669	1274	1585	1729	46.4	19.6			DBHS 160 15 DDD EU
		2	440	261	714	1361	1692	1846					
		3	628	372	1018	1939	2412	2631					
180		1	421	250	716	1364	1696	1850	46.4	19.6			DBHS 180 15 DDD EU
		2	449	266	764	1456	1811	1975					
		3	640	380	1089	2076	2582	2816					
200		1	529	314	858	1635	2033	2218	47.1	23.5			DBHS 200 15 DDD EU
		2	557	331	904	1722	2142	2337					
		3	804	477	1304	2486	3092	3372					
220		1	587	348	952	1815	2257	2462	47.8	27.5			DBHS 220 15 DDD EU
		2	612	363	992	1890	2351	2565					
		3	893	530	1447	2759	3432	3743					
240		1	646	383	1047	1995	2481	2707	48.1	29.7			DBHS 240 15 DDD EU
		2	669	397	1085	2068	2572	2805					
		3	981	582	1591	3032	3771	4113					
260		1	654	388	1094	2085	2593	2828	48.1	29.7			DBHS 260 15 DDD EU
		2	678	402	1133	2160	2687	2931					
		3	994	590	1662	3168	3941	4298					
280		1	762	452	1236	2355	2930	3195	48.9	34.5			DBHS 280 15 DDD EU
		2	779	462	1263	2408	2995	3267					
		3	1158	687	1877	3578	4451	4855					

Afgetes gemeten volgens EN 16430.

sturing:  
Jaga ACO (D09)  
Jaga BMS 0-10V regeling (D03)  
Jaga TPT (D01)

# DBH SET 15 + LOW-H2O TYPE 16



LENGTE RADIATOR			KOELEN Kamertemperatuur 27°C				VERWARMEN Kamertemperatuur 20°C				GELUIDSDRUK*				BESTELCODE
L	DBH SET	STAND	16/18	20/22	35/30	45/40	50/45	55/45	dB(A)	OPGENOMEN ELEKTRISCH VERMOGEN	GEWICHT	WATERINHOUD			
cm	cm		Watt	Watt	Watt	Watt	Watt	Watt	Watt	kg	L				
DBHS	060	15	1	214	131	301	581	726	793	41.1	7.2				DBHS 060 15 DDD EU
			2	<b>230</b>	<b>141</b>	<b>323</b>	<b>624</b>	<b>779</b>	<b>851</b>						
			3	305	187	428	826	1031	1126						
	070		1	220	134	350	676	844	922	41.1	7.2			DBHS 070 15 DDD EU	
			2	<b>236</b>	<b>144</b>	<b>376</b>	<b>725</b>	<b>906</b>	<b>990</b>						
			3	312	191	498	960	1199	1310						
	080		1	312	191	439	847	1058	1156	42.4	9.0			DBHS 080 15 DDD EU	
			2	<b>335</b>	<b>205</b>	<b>471</b>	<b>908</b>	<b>1134</b>	<b>1239</b>						
			3	450	275	632	1219	1522	1663						
	090		1	358	219	503	970	1211	1323	43.3	10.7			DBHS 090 15 DDD EU	
			2	<b>383</b>	<b>235</b>	<b>539</b>	<b>1039</b>	<b>1298</b>	<b>1418</b>						
			3	522	319	734	1415	1767	1931						
	100		1	403	247	566	1092	1364	1490	44.1	10.7			DBHS 150 15 DDD EU	
			2	<b>431</b>	<b>264</b>	<b>606</b>	<b>1169</b>	<b>1460</b>	<b>1595</b>						
			3	595	364	836	1612	2013	2199						
	110		1	408	250	613	1183	1477	1614	44.1	12.5			DBHS 115 15 DDD EU	
			2	<b>437</b>	<b>267</b>	<b>657</b>	<b>1267</b>	<b>1582</b>	<b>1728</b>						
			3	602	368	905	1746	2181	2382						
	120		1	496	304	698	1346	1681	1836	44.8	14.3			DBHS 120 15 DDD EU	
			2	<b>532</b>	<b>326</b>	<b>747</b>	<b>1441</b>	<b>1800</b>	<b>1966</b>						
			3	740	453	1039	2005	2504	2735						
	140		1	589	360	827	1596	1993	2177	45.4	16.1			DBHS 140 15 DDD EU	
			2	<b>630</b>	<b>386</b>	<b>886</b>	<b>1709</b>	<b>2134</b>	<b>2332</b>						
			3	885	542	1243	2398	2995	3272						
	160		1	676	414	951	1834	2290	2502	46.4	19.6			DBHS 160 15 DDD EU	
			2	<b>722</b>	<b>442</b>	<b>1015</b>	<b>1958</b>	<b>2445</b>	<b>2671</b>						
			3	1030	630	1447	2791	3486	3808						
	180		1	686	420	1042	2011	2511	2743	46.4	19.6			DBHS 180 15 DDD EU	
			2	<b>733</b>	<b>448</b>	<b>1113</b>	<b>2147</b>	<b>2681</b>	<b>2929</b>						
			3	1045	639	1586	3060	3821	4175						
	200		1	868	531	1220	2352	2938	3210	47.1	23.5			DBHS 200 15 DDD EU	
			2	<b>914</b>	<b>559</b>	<b>1285</b>	<b>2479</b>	<b>3096</b>	<b>3382</b>						
			3	1003	808	1855	3577	4468	4881						
	220		1	963	590	1354	2612	3262	3563	47.8	27.5			DBHS 220 15 DDD EU	
			2	<b>1320</b>	<b>614</b>	<b>1410</b>	<b>2721</b>	<b>3398</b>	<b>3712</b>						
			3	1098	896	2058	3970	4958	5417						
	240		1	1059	648	1488	2871	3586	3917	48.1	29.7			DBHS 240 15 DDD EU	
			2	<b>1108</b>	<b>672</b>	<b>1543</b>	<b>2975</b>	<b>3716</b>	<b>4060</b>						
			3	1610	985	2262	4363	5449	5953						
	260		1	1069	654	1580	3048	3806	4158	48.1	29.7			DBHS 260 15 DDD EU	
			2	<b>1465</b>	<b>678</b>	<b>1638</b>	<b>3159</b>	<b>3945</b>	<b>4310</b>						
			3	1625	994	2402	4632	5785	6320						
	280		1	1250	765	1757	3390	4233	4625	48.9	34.5			DBHS 280 15 DDD EU	
			2	<b>1278</b>	<b>782</b>	<b>1797</b>	<b>3465</b>	<b>4328</b>	<b>4728</b>						
			3	1900	1163	2670	5150	6431	7026						

Afgettes gemeten volgens EN 16430.

sturing:  
Jaga ACO (D09)  
Jaga BMS 0-10V regeling (D03)  
Jaga TPT (D01)

# DBH SET 15 + LOW-H2O TYPE 20

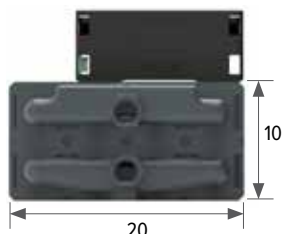

LENGTE RADIATOR L cm	DBH SET B cm	STAND	KOELEN Kamertemperatuur 27°C		VERWARMEN Kamertemperatuur 20°C				GELUIDSDRUK* dB(A)	OPGENOMEN ELEKTRISCH VERMOGEN Watt	GEWICHT kg	WATERINHOUD L	BESTELCODE
			16/18 Watt	20/22 Watt	35/30 Watt	45/40 Watt	50/45 Watt	55/45 Watt					
			1	2	3	1	2	3					
DBHS 060	15	1	166	102	298	568	706	771	41.1	7.2			DBHS 060 15 DDD EU
		2	178	109	319	608	757	825					
		3	211	129	378	720	895	976					
070	15	1	171	104	334	637	792	864	41.1	7.2			DBHS 070 15 DDD EU
		2	183	112	358	683	849	927					
		3	219	134	428	817	1016	1108					
080	15	1	240	147	430	819	1019	1112	42.4	9.0			DBHS 080 15 DDD EU
		2	258	158	462	880	1095	1194					
		3	311	190	557	1062	1321	1441					
090	15	1	276	169	494	942	1171	1278	43.3	10.7			DBHS 090 15 DDD EU
		2	297	182	532	1013	1260	1374					
		3	361	221	647	1234	1534	1674					
100	15	1	311	191	557	1062	1321	1441	44.1	10.7			DBHS 100 15 DDD EU
		2	335	205	601	1145	1424	1553					
		3	412	252	737	1405	1748	1906					
110	15	1	317	194	596	1136	1413	1541	44.1	12.5			DBHS 110 15 DDD EU
		2	342	209	642	1224	1522	1660					
		3	419	257	788	1502	1868	2038					
120	15	1	381	233	682	1299	1616	1762	44.8	14.3			DBHS 120 15 DDD EU
		2	411	252	736	1403	1746	1904					
		3	512	313	917	1748	2174	2371					
140	15	1	448	274	803	1530	1903	2076	45.4	16.1			DBHS 140 15 DDD EU
		2	486	297	870	1657	2062	2249					
		3	612	375	1097	2090	2600	2836					
160	15	1	515	315	922	1757	2186	2384	46.4	19.6			DBHS 160 15 DDD EU
		2	559	342	1001	1907	2373	2588					
		3	713	436	1276	2433	3026	3301					
180	15	1	526	322	995	1897	2360	2574	46.4	19.6			DBHS 180 15 DDD EU
		2	571	350	1081	2059	2562	2794					
		3	728	446	1378	2627	3267	3564					
200	15	1	644	394	1154	2200	2736	2984	47.1	23.5			DBHS 200 15 DDD EU
		2	702	430	1258	2397	2982	3253					
		3	914	559	1636	3118	3879	4230					
220	15	1	704	431	1261	2403	2989	3260	47.8	27.5			DBHS 220 15 DDD EU
		2	769	471	1377	2625	3265	3562					
		3	1014	621	1816	3461	4305	4695					
240	15	1	763	467	1367	2605	3240	3534	48.1	29.7			DBHS 240 15 DDD EU
		2	836	512	1497	2854	3550	3872					
		3	1114	682	1996	3804	4731	5160					
260	15	1	768	470	1426	2718	3381	3688	48.1	29.7			DBHS 260 15 DDD EU
		2	848	519	1573	2998	3729	4067					
		3	1130	692	2097	3997	4972	5423					
280	15	1	894	547	1602	3052	3797	4141	48.9	34.5			DBHS 280 15 DDD EU
		2	987	604	1768	3370	4192	4572					
		3	1315	805	2355	4489	5583	6090					

Afgettes gemeten volgens EN 16430.

sturing:  
Jaga ACO (D09)  
Jaga BMS 0-10V regeling (D03)  
Jaga TPT (D01)



# DBH SET 15 + LOW-H2O TYPE 21

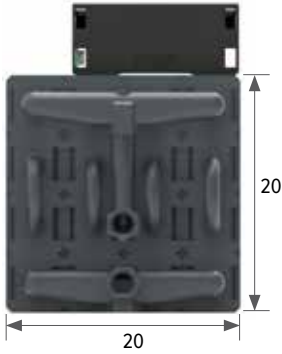

LENGTE RADIATOR			KOELEN Kamertemperatuur 27°C		VERWARMEN Kamertemperatuur 20°C				GELUIDSDRUK*	OPGENOMEN ELEKTRISCH VERMOGEN	GEWICHT	WATERINHOUD	BESTELCODE	
L	B	STAND	16/18	20/22	35/30	45/40	50/45	55/45	dB(A)	Watt	kg	L		
cm	cm		Watt	Watt	Watt	Watt	Watt	Watt						
DBHS 060	060	15	1	234	151	416	779	963	1048	41.1	7.2			DBHS 060 15 DDD EU
				251	162	447	836	1034	1125					
				332	214	591	1106	1368	1488					
070	070	15	1	240	155	456	854	1056	1149	41.1	7.2			DBHS 070 15 DDD EU
				258	166	490	917	1134	1234					
				341	220	648	1214	1501	1633					
080	080	15	1	341	220	606	1135	1404	1527	42.4	9.0			DBHS 080 15 DDD EU
				366	236	650	1217	1505	1638					
				490	316	872	1633	2019	2197					
090	090	15	1	390	252	694	1300	1607	1749	43.3	10.7			DBHS 090 15 DDD EU
				418	270	744	1393	1722	1874					
				570	367	1013	1897	2345	2552					
100	100	15	1	439	283	782	1464	1809	1969	44.1	10.7			DBHS 150 15 DDD EU
				471	303	837	1567	1937	2108					
				649	418	1154	2160	2671	2906					
110	110	15	1	446	287	821	1536	1899	2067	44.1	12.5			DBHS 115 15 DDD EU
				477	308	879	1645	2034	2213					
				658	424	1211	2268	2804	3051					
120	120	15	1	542	349	963	1804	2230	2426	44.8	14.3			DBHS 120 15 DDD EU
				580	374	1032	1932	2388	2598					
				807	520	1435	2687	3322	3615					
140	140	15	1	642	414	1143	2139	2645	2877	45.4	16.1			DBHS 140 15 DDD EU
				688	443	1224	2291	2832	3082					
				965	622	1717	3214	3974	4324					
160	160	15	1	738	476	1313	2458	3039	3307	46.4	19.6			DBHS 160 15 DDD EU
				788	508	1402	2624	3245	3530					
				1123	724	1998	3741	4625	5033					
180	180	15	1	750	483	1388	2599	3214	3497	46.4	19.6			DBHS 180 15 DDD EU
				801	516	1482	2775	3431	3733					
				1142	736	2113	3956	4891	5322					
200	200	15	1	947	610	1684	3153	3898	4242	47.1	23.5			DBHS 200 15 DDD EU
				998	643	1775	3322	4108	4469					
				1440	928	2561	4795	5928	6450					
220	220	15	1	1051	677	1870	3501	4328	4709	47.8	27.5			DBHS 220 15 DDD EU
				1095	706	1948	3646	4508	4905					
				1598	1030	2843	5322	6579	7159					
240	240	15	1	1155	745	2056	3848	4758	5177	48.1	29.7			DBHS 240 15 DDD EU
				1197	772	2130	3988	4931	5365					
				1756	1132	3124	5849	7231	7868					
260	260	15	1	1168	752	2131	3990	4933	5367	48.1	29.7			DBHS 260 15 DDD EU
				1210	780	2209	4135	5112	5562					
				1774	1144	3239	6064	7497	8157					
280	280	15	1	1364	879	2427	4543	5617	6112	48.9	34.5			DBHS 280 15 DDD EU
				1395	899	2481	4645	5743	6249					
				2072	1336	3687	6902	8534	9285					

Afmetingen gemeten volgens EN 16430.

sturing:  
Jaga ACO (D09)  
Jaga BMS 0-10V regeling (D03)  
Jaga TPT (D01)

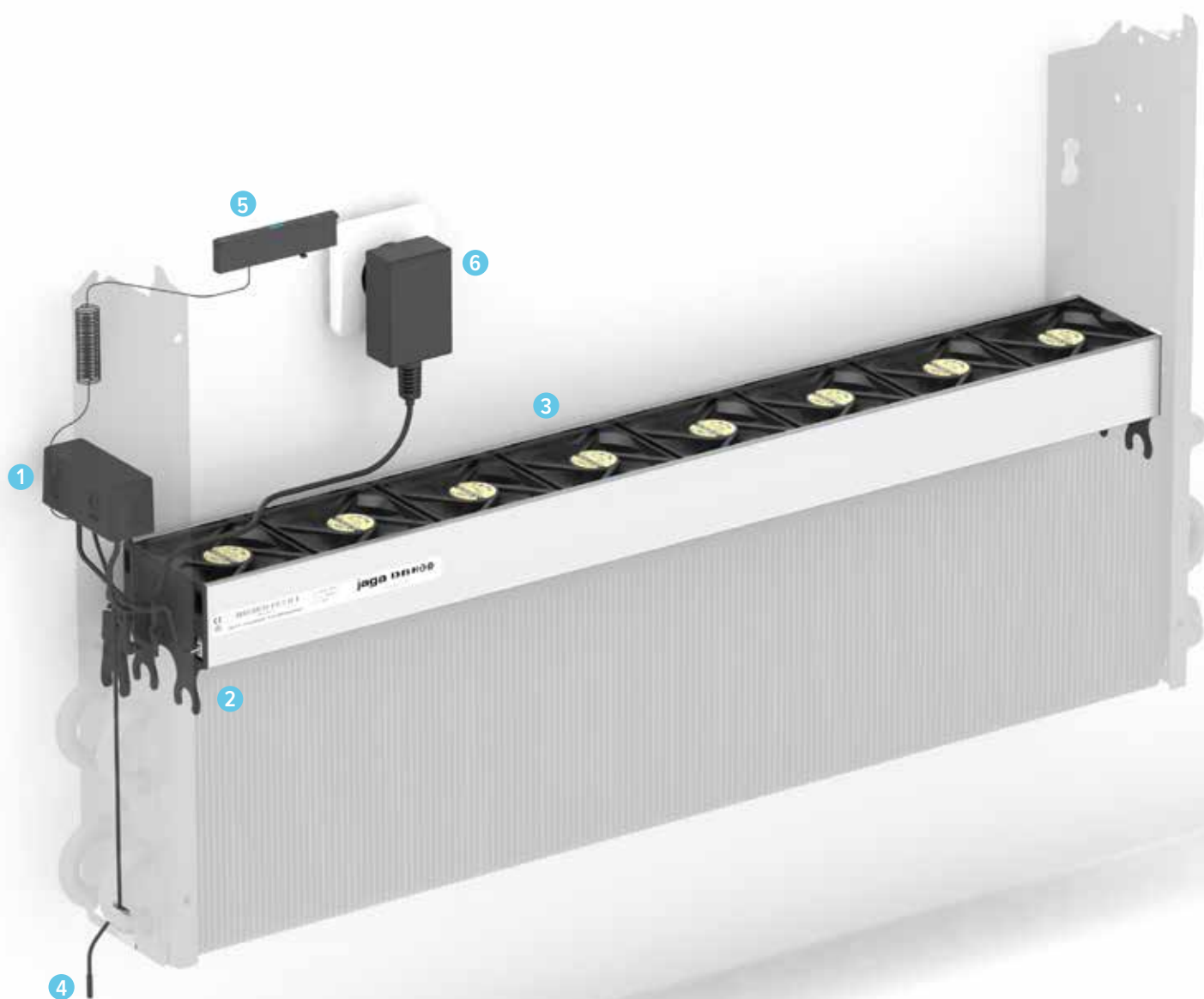

1 Kleef de controller tegen de console.



2 Klik de watertemperatuursensor op de warmtewisselaar.



3 Sluit de ventilator-unit aan op de controller en klik deze op de warmtewisselaar.

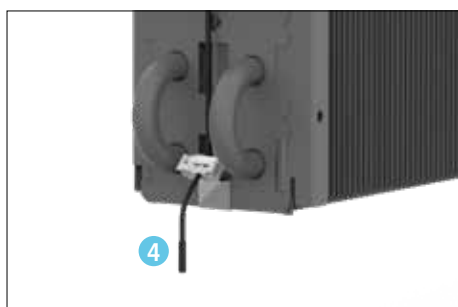

4 Bevestig de ruimtetemperatuursensor.

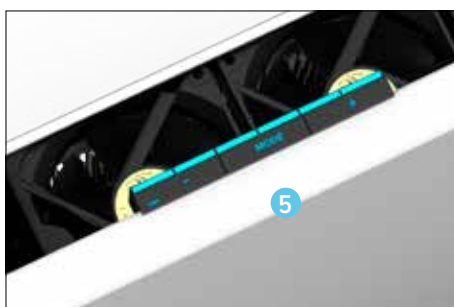

5 Plaats de bekleding terug op de radiator, maar zonder rooster. Plaats de bediening op het voorpaneel.



6 Steek stekker in stopcontact en plaats de rooster terug op de radiator.

De opgegeven vermogens bij  $\Delta T$  50 zijn exacte waarden, gemeten volgens EN442. Voor alle andere  $\Delta T$  geeft deze tabel een berekende waarde aan de hand van een gemiddelde correctiefactor geldig voor alle afmetingen.

Op [www.jaga.com/selection-tools/](http://www.jaga.com/selection-tools/) kunt u berekeningstools downloaden met de exacte afgiftes. De online berekeningstools worden steeds up to date gehouden met de meest recente gegevens. Minieme afgifteverschillen tussen reeds gedrukte tabellen en de verschillende online berekeningstools zijn daarom volstrekt normaal en vallen binnen de door de norm vastgelegde tolerantie marges.

## GEMIDDELDE CORRECTIEFACTOREN HYBRID PRODUCTEN - 75/65/20°C

Kamertemperatuur: 20°C Gemiddelde N-waarde: 1.10

	TR	65	60	55	50	45	40	35	30	25
TA										
75	1.00	0.94	0.88	0.81	0.74	0.67	0.59	0.50	0.38	
70	0.95	0.89	0.83	0.77	0.70	0.63	0.55	0.47	0.36	
65		0.84	0.78	0.72	0.66	0.59	0.52	0.43	0.33	
60			0.73	0.67	0.61	0.55	0.48	0.40	0.30	
55				0.62	0.57	0.51	0.44	0.37	0.28	
50					0.52	0.46	0.40	0.33	0.25	
45						0.42	0.36	0.29	0.22	
40							0.31	0.26	0.19	
35								0.22	0.15	
30									0.12	

Kamertemperatuur: 24°C Gemiddelde N-waarde: 1.10

	TR	65	60	55	50	45	40	35	30	25
TA										
75		0.91	0.85	0.79	0.72	0.65	0.58	0.49	0.39	0.22
70		0.86	0.80	0.74	0.68	0.61	0.54	0.46	0.36	0.20
65			0.75	0.69	0.63	0.57	0.50	0.42	0.33	0.19
60				0.64	0.59	0.53	0.46	0.39	0.30	0.17
55					0.54	0.48	0.42	0.35	0.27	0.15
50						0.44	0.38	0.32	0.24	0.13
45							0.33	0.28	0.21	0.11
40								0.23	0.17	0.09
35									0.14	0.07
30										0.04

## CORRECTIEFACTOREN KOELVERMOGEN VOOR TYPE 11, 16 EN 21

HOOGTE	CORRECTIEFACTOR
20 - 30 - 40 - 50	1.00
60	0.95
65	0.92
70	0.90
80	0.85
90	0.80
95	0.77
100	0.75

# RADIATOREN MET DBH UPGRADE SET

## RICHTLIJN VOOR HET BEPERKEN VAN STROMINGSGELUIDEN

Buis	Buiten Ø	Wand- dikte	Max. watersnelheid (EN10255)	waterinhoud per meter	max. waterdebiet	Maximaal vermogen bij ΔT (°C) (T aanvoer - T retour)						
						ΔT 30	ΔT 20	ΔT 10	ΔT 5	ΔT 4	ΔT 3	ΔT 2
						Watt	Watt	Watt	Watt	Watt	Watt	Watt
<b>GALVA BUIS DIN 2440</b>												
3/8 DN10 OD	17.2	2.35	0.40	0.12	173	6028	4019	2009	1005	804	603	402
1/2 DN15 OD	21.3	2.65	0.40	0.20	288	10046	6698	3349	1674	1340	1005	670
3/4 DN20 OD	26.9	2.65	0.42	0.37	559	19515	13010	6505	3253	2602	1952	1301
1 DN25 OD	33.7	3.25	0.49	0.58	1023	35690	23793	11897	5948	4759	3569	2379
1 1/4 DN32 OD	42.4	3.25	0.60	1.01	2182	76101	50734	25367	12684	10147	7610	5073
1 1/2 DN40 OD	48.3	3.25	0.66	1.37	3255	113549	75700	37850	18925	15140	11355	7570
2 DN50 OD	60.3	3.65	0.80	2.21	6365	222025	148017	74008	37004	29603	22203	14802
<b>DUNWANDIG METAAL</b>												
10/1	10	1.00	0.40	0.05	72	2512	1674	837	419	335	251	167
12/1	12	1.00	0.40	0.08	115	4019	2679	1340	670	536	402	268
14/1	14	1.00	0.40	0.11	158	5526	3684	1842	921	737	553	368
15/1	15	1.00	0.40	0.13	187	6530	4353	2177	1088	871	653	435
16/1	16	1.00	0.40	0.15	216	7535	5023	2512	1256	1005	753	502
18/1	18	1.00	0.40	0.20	288	10046	6698	3349	1674	1340	1005	670
22/1	22	1.00	0.40	0.31	446	15572	10381	5191	2595	2076	1557	1038
28/1	28	1.00	0.47	0.53	904	31522	21014	10507	5254	4203	3152	2101
<b>VPE/ALU</b>												
12/2	12	2.00	0.40	0.05	72	2512	1674	837	419	335	251	167
14/2	14	2.00	0.40	0.08	115	4019	2679	1340	670	536	402	268
16/1.5	16	1.50	0.40	0.13	187	6530	4353	2177	1088	871	653	435
16/2	16	2.00	0.40	0.11	158	5526	3684	1842	921	737	553	368
17/2	17	2.00	0.40	0.13	187	6530	4353	2177	1088	871	653	435
18/2	18	2.00	0.40	0.15	216	7535	5023	2512	1256	1005	753	502
20/2	20	2.00	0.40	0.20	288	10046	6698	3349	1674	1340	1005	670
26/3	26	3.00	0.40	0.31	446	15572	10381	5191	2595	2076	1557	1038
32/3	32	3.00	0.47	0.53	904	31522	21014	10507	5254	4203	3152	2101
40/3.5	40	3.50	0.56	0.86	1726	60220	40147	20073	10037	8029	6022	4015
50/4.25	50	4.25	0.66	1.35	3206	111824	74549	37275	18637	14910	11182	7455
63/5	63	5.00	0.80	2.21	6346	221359	147573	73786	36893	29515	22136	14757

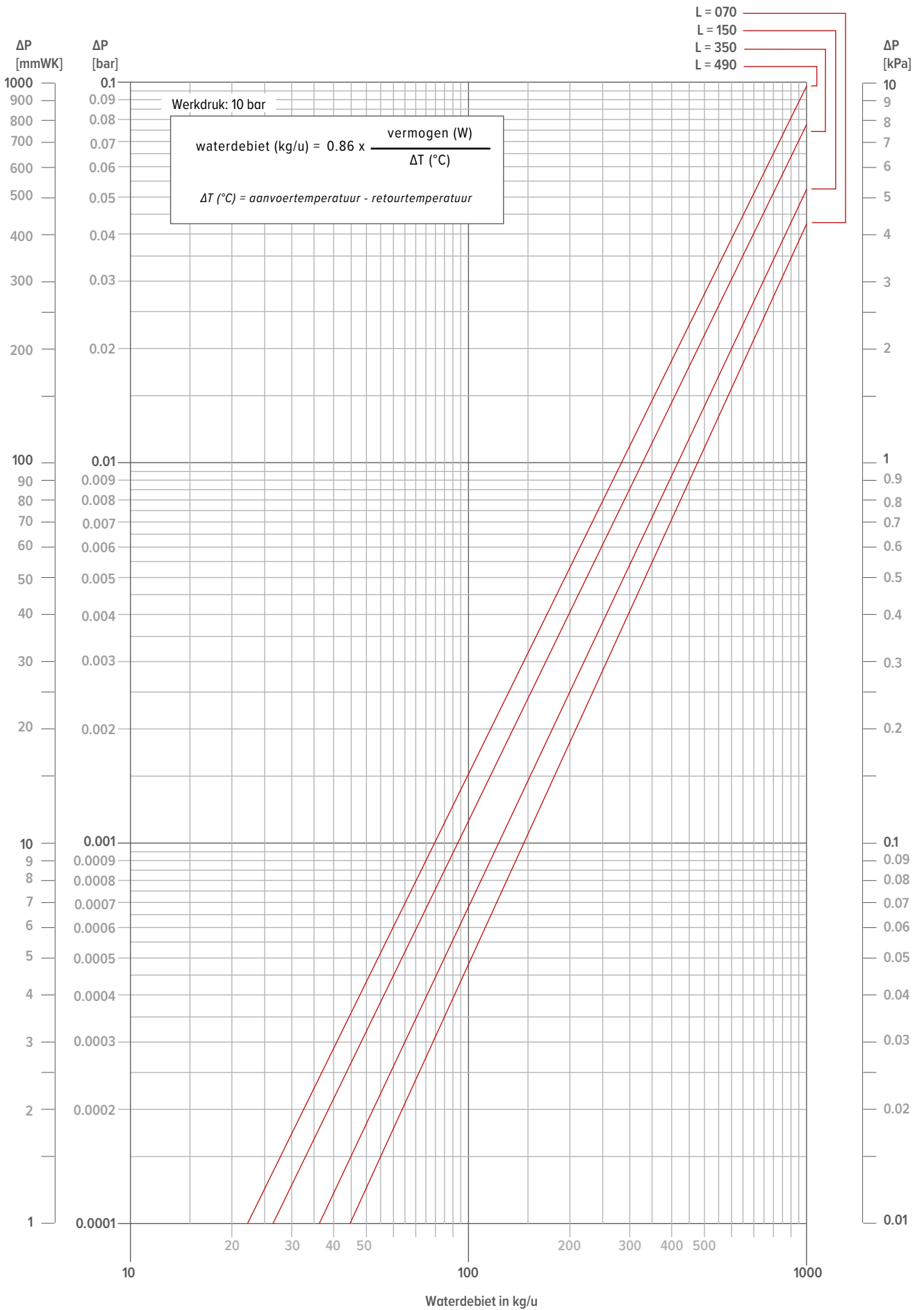

L = 070  
 L = 150  
 L = 280

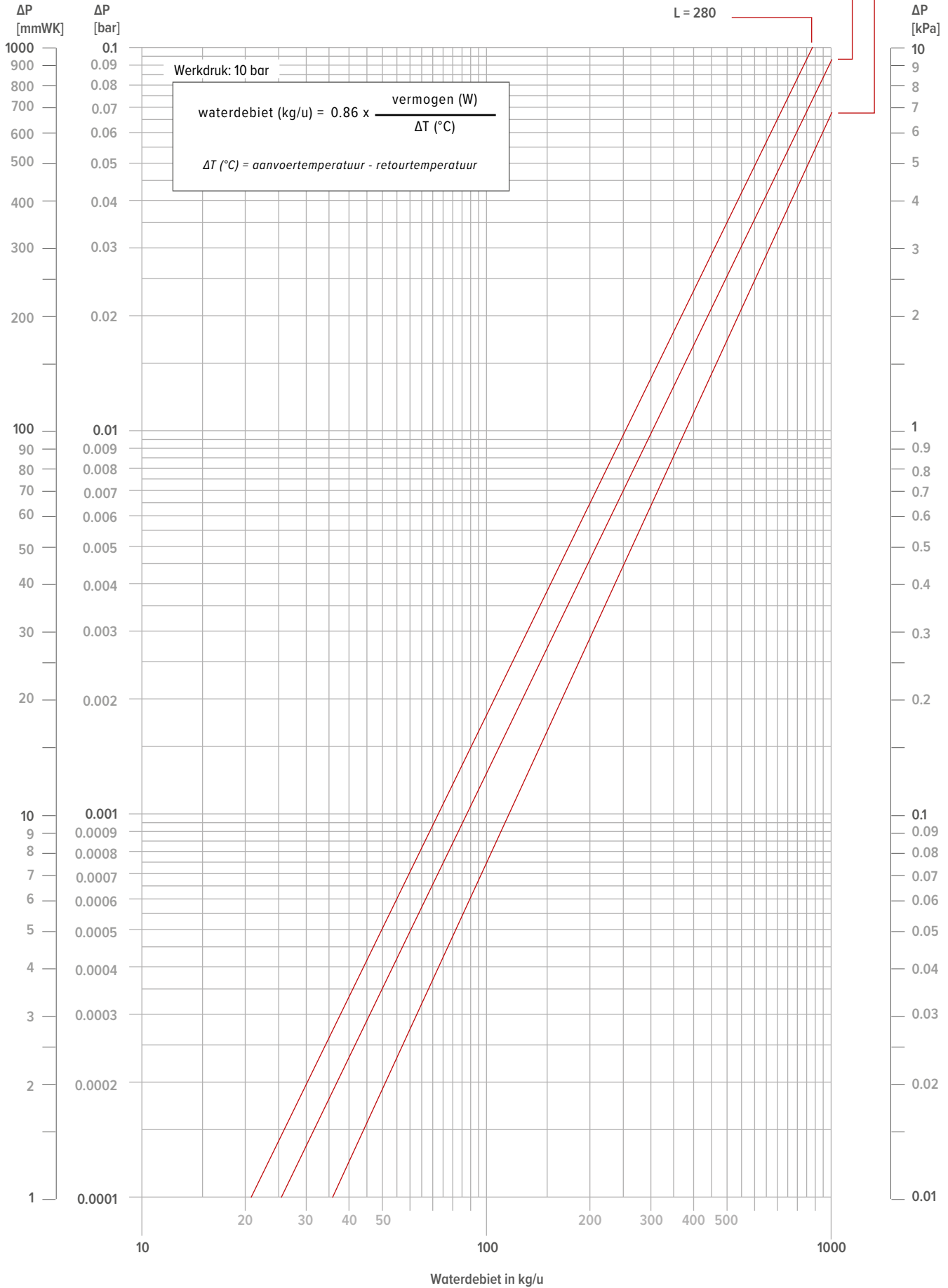

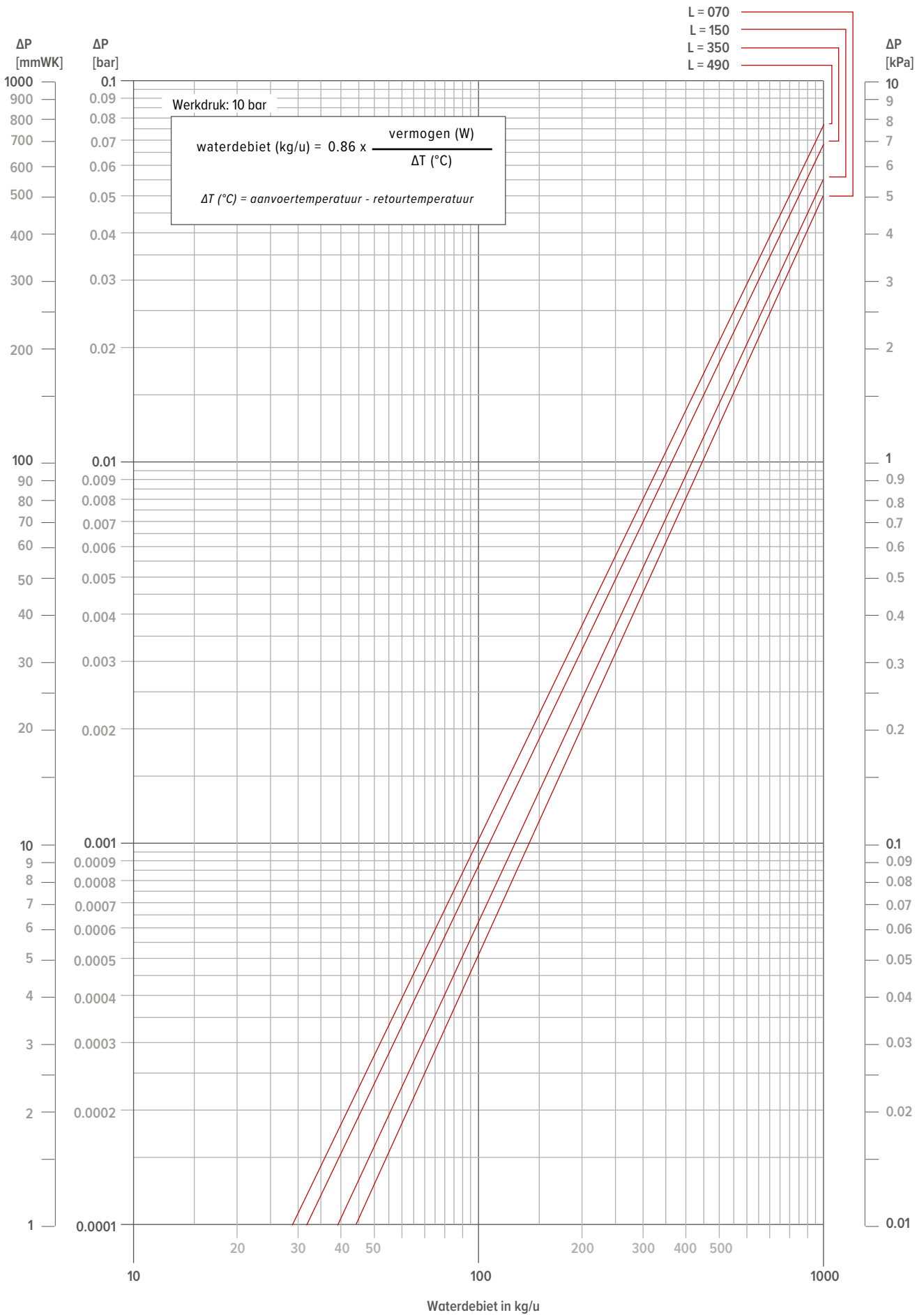

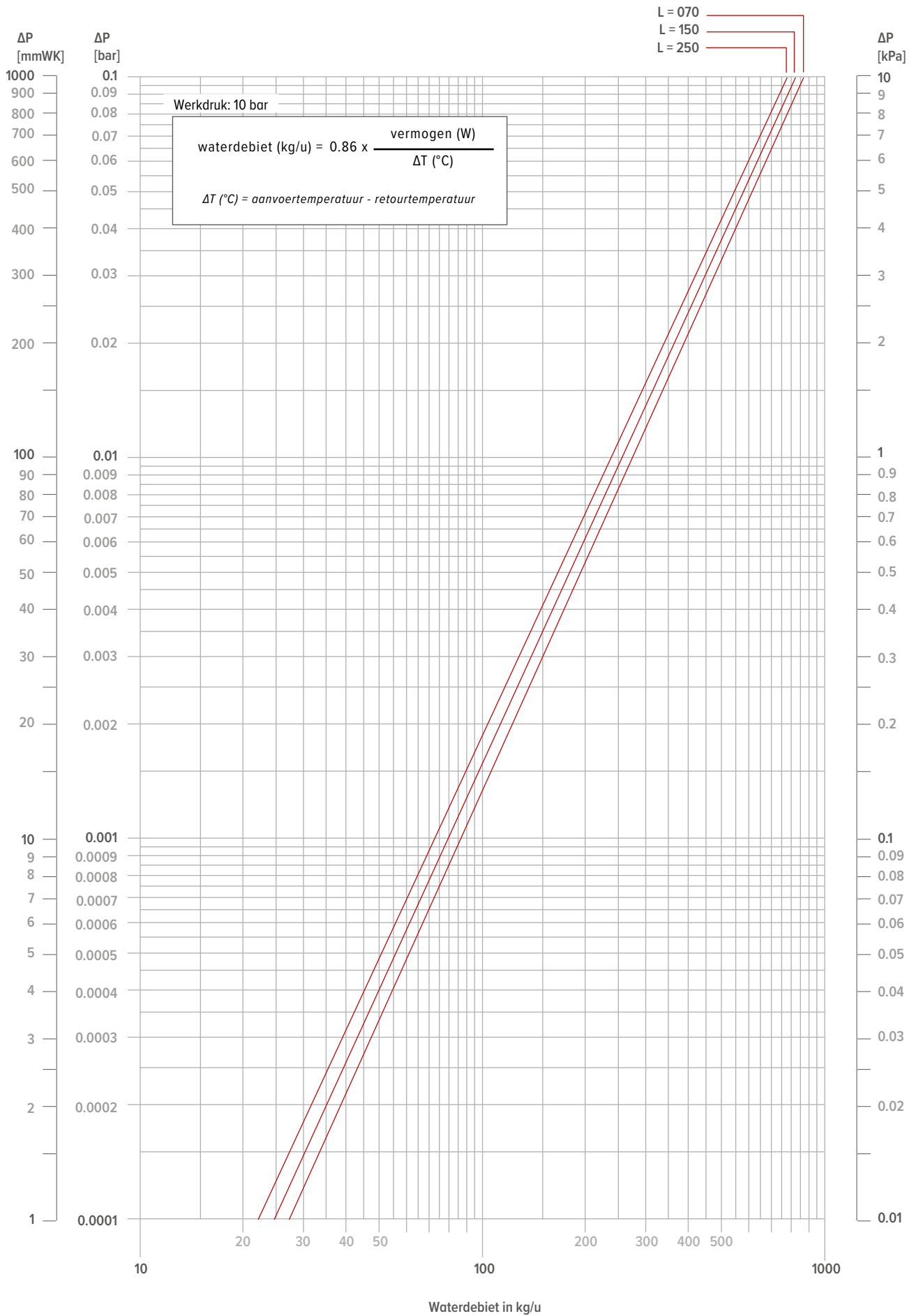



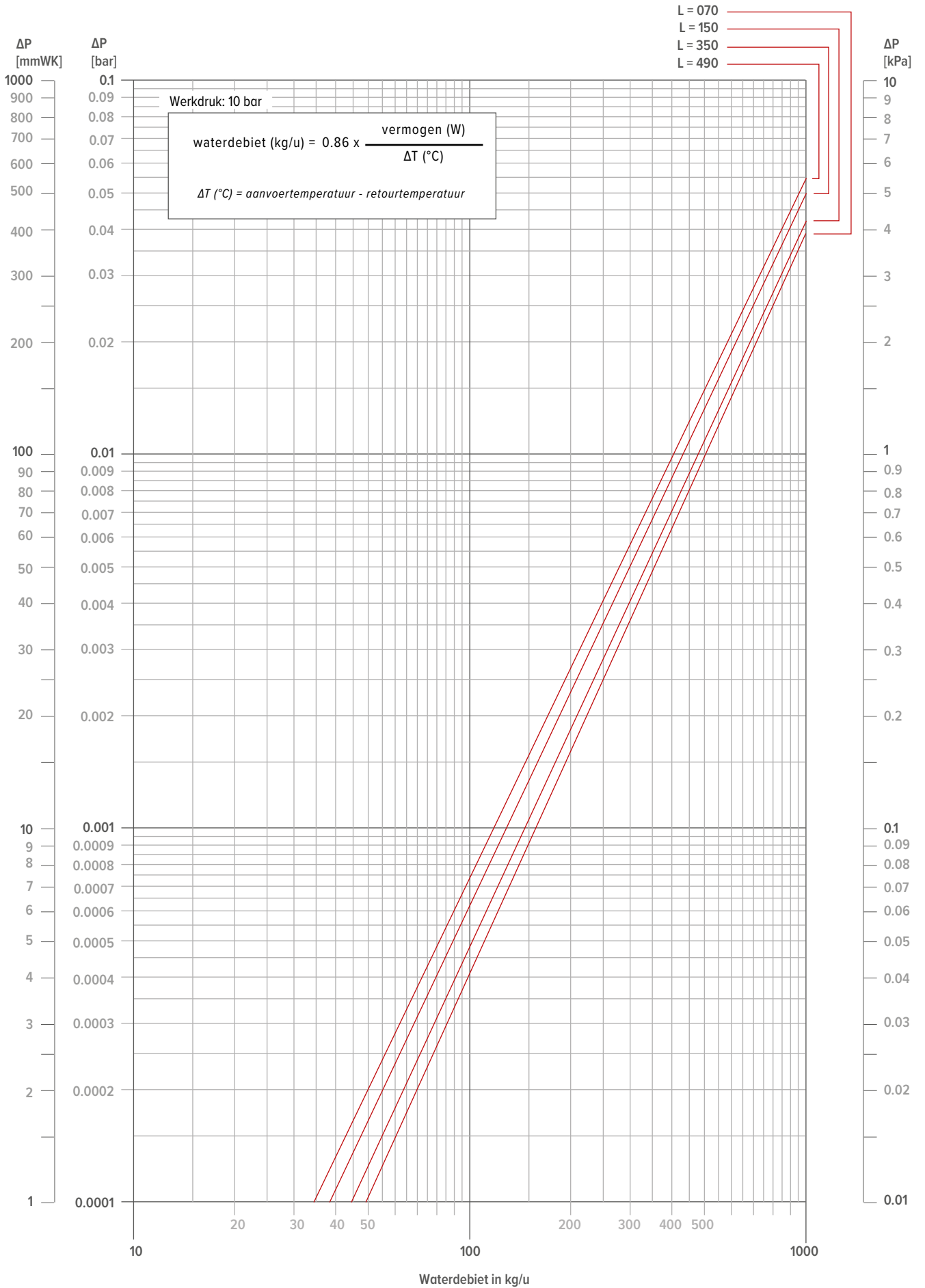

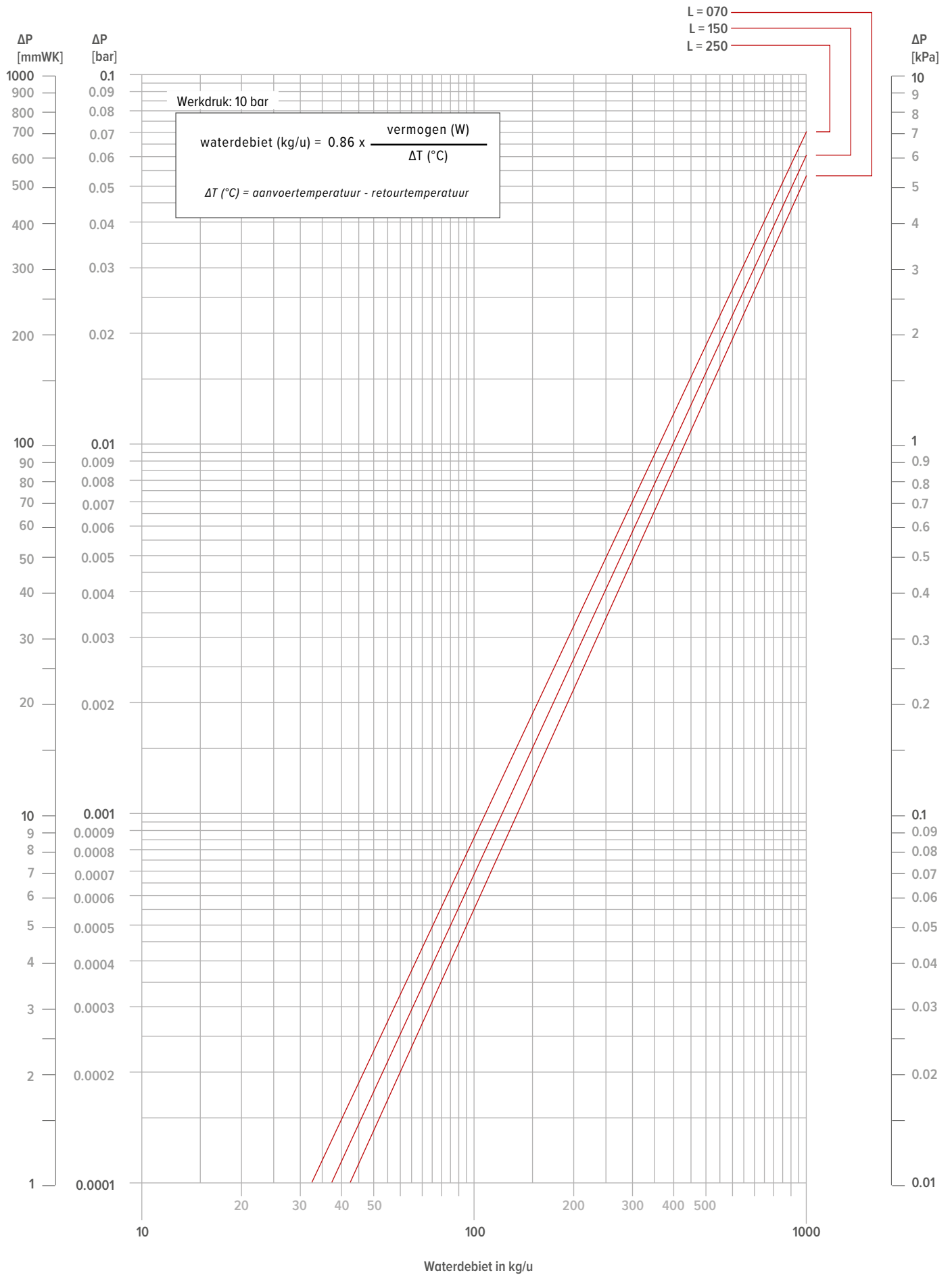





**jaga**

CLIMATE  
DESIGNERS

**BELGIË JAGA NV**

Nood aan advies? Maak een afspraak in het Jaga Advies Centrum!

Verbindingslaan 16  
3590 Diepenbeek

+32 (0) 11 29 41 11

info@jaga.be  
jaga.com